

# A Generalised Approach to the Temporal Optimisation Cycle of an Assembly/Disassembly Mechatronics Line Served by Mobile Robot with Manipulator

MINCA Eugenia

“Dunarea de Jos” University of Galati, Department of Automation and Electrical Engineering; Galati 800008  
“Valahia” University of Targoviste, Department of Automation, Computer Science and Electrical Engineering, Targoviste 130082  
E-mail: minca@valahia.ro, eugenia.minca@gmail.com

**Abstract:** This paper deals time cycle optimisation for a hybrid systems composed of repetitive tasks. In this respect it is proposed a generalised Synchronized Hybrid Petri Nets (SHPN) models used in modeling and control of an Assembly/Disassembly Mechatronics Line (A/DML), with “n” workstations, served by a wheeled mobile robot (WMR) equipped with robotic manipulator (RM). The SHPN model is a hybrid type, where A/DML is the discrete part and WMR with RM is the continuous part. Moreover, the model operates as a synchronized with signals from sensors. The disassembly process starts after the assembly process and final piece fails the quality test, in order to recover the parts. The WMR with RM is used only in disassembling process, in order to transport the parts from the disassembling locations to the storage locations. Thus, the A/DML becomes reversible. Disassembly time cycle optimization requires to calculate the optimal WMR speed in order to minimize the travel duration between workstations. Using a LabView platform and A/DLB and SHPN models, get a real-time control structure.

**Key Words:** assembly/disassembly mechatronics line, time cycle, wheeled mobile robot, robotic manipulator, Petri nets

## 1. Introduction

This paper propose a time cycle optimization for a hybrid systems composed of repetitive tasks and a generalized Synchronized Hybrid Petri Nets (SHPN) dedicated for hybrid repetitive process model. The tool SHPN is dedicated to control modeling of a hybrid systems, composed of repetitive tasks series where the repetitive components are defined as elementary operations. Model elaboration for entire process requires using dedicated instruments for discrete event systems (DES) model but adapted of repetitive tasks and synchronized tasks description.

The proposal will be tested for a reversible assembly/disassembly manufacturing line (A/DML) served by a wheeled mobile robot (WMR) equipped with robotic manipulator (RM). The objective is to make the assembly line reversible, i.e. to allow disassembly.

In this paper, the concepts of assembly/disassembly tasks are illustrated in SHPN model which respect both aspects: the discrete approach for the elementary assembly/disassembly operations and the continuous approach for displacement of WMR. The considered system is a hybrid one and requires specialized tools for modeling, as in (David and Alla, 2010). The hybrid model is elaborated using the dedicated modeling tool HPN, described in (Filipescu, *et al.*, 2012) and (Radaschin, *et al.*, 2011). Combining the SED model of the analyzed system with the cyclic and continuous time of the WMR with RM results a SHPN model. This paper is organized as follows: the description of A/DML served by WMR with RM and SHPN

model, in generalized and customized forms, are presented in Section 2; the generalized and customized SHPN formalism is presented in Section 3. Section 4 is reserved to the optimization of the time cycle corresponding to the control of repetitive processes; Section 5 proposes real-time control based on A/DML and SHPN models; some conclusion remarks can be found in Section 6.

## 2. General Structure of the A/DML Served by WMR with RM

The system of reversible assembly/disassembly line served by robotic manipulators mounted on mobile platforms has a dynamics determined both, by events (events supplied by the control sequences of the automation system) and by the interaction with the WMR, which represent the continuous time component of the system. The assembly/disassembly operation can be decomposed into a sequence of elementary assembly tasks coupled in parallel with positioning tasks of work-piece along conveyor, as in (Baldwin, *et al.*, 1991; Choi, *et al.*, 1998; Ganget, *et al.*, 2005). The hybrid assembly/disassembly strategy is based on the hierarchical model proposed in (Selinger, *et al.*, 1999; Radaschin, 2011; Radaschin *et al.*, 2012; Kopacek, and Kopacek, 1999) which uses the general representation from Fig. 1:

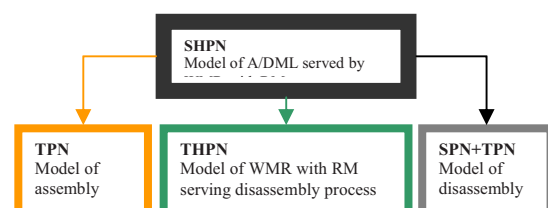

Fig. 1: Structure of SHPN model.

\*This work was supported by UEFISCDI, project number PN-II-ID-PCE-2011-3-0641

SHPN structure from Fig. 1 is obtained by modeling of assembly/disassembly and continuous service assistance, for disassembly operations, performed by mobile platform equipped with manipulator:

- Assembling/storage in warehouses (TPN typology: Fig.2);
- Disassembling of damaged product (SPN and TPN typologies: Fig.3);
- Service assistance, during disassembling process, performed by the mobile robot equipped with manipulator (THPN typology: Fig.3).

The entire model is SHPN type because it is interfaced with external events for synchronization in an approach of modeling/simulation, useful in real-time control. SHPN morphology results by integration three PN models.

During disassembly process can identify a repetitive sequence associated to a single disassembly operation and service assistance of WMR equipped with RM. All of these

can be modelled with a SHPN, called elementary SHPN, as is represented in Fig. 3.  $E_{dd(j)}^1$  and  $E_{dd(j+2)}^2$  are external events from the sensors used for line synchronization with the WMR equipped with RM.  $E_{dd(j)}^1$  is an external synchronization signal, corresponding to STOPPING line and STARTING disassembly.  $E_{dd(j+2)}^2$  is an external synchronization signals, corresponding to PICKING UP of disassembled component and STARTING line. All of these can be modelled with a SHPN, called elementary SHPN, as is represented in Fig. 3.

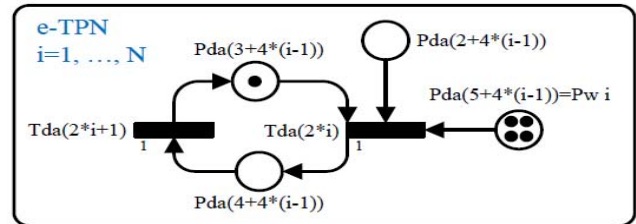

Fig.2: e-TPN model for an elementary assembly operation

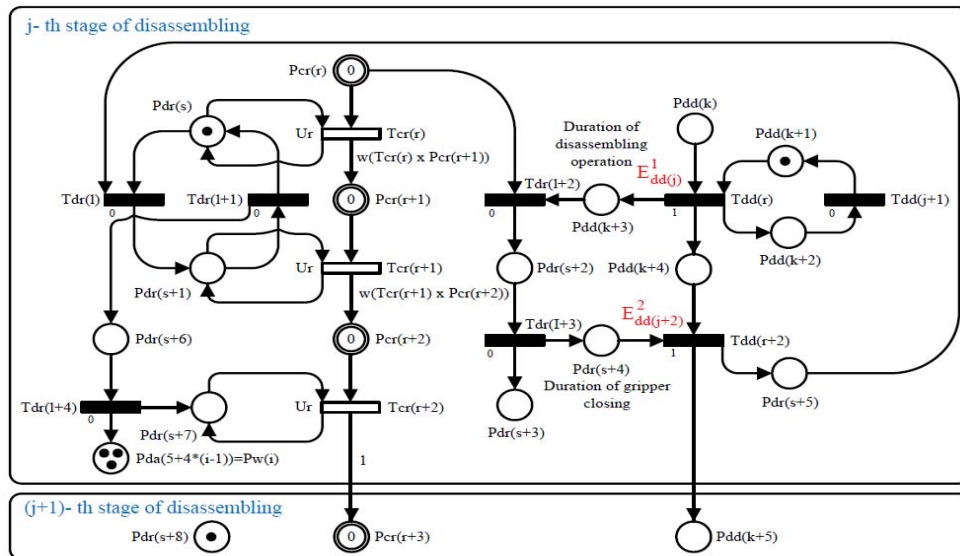

Fig.3: e-SHPN model of j-th elementary disassembly operation

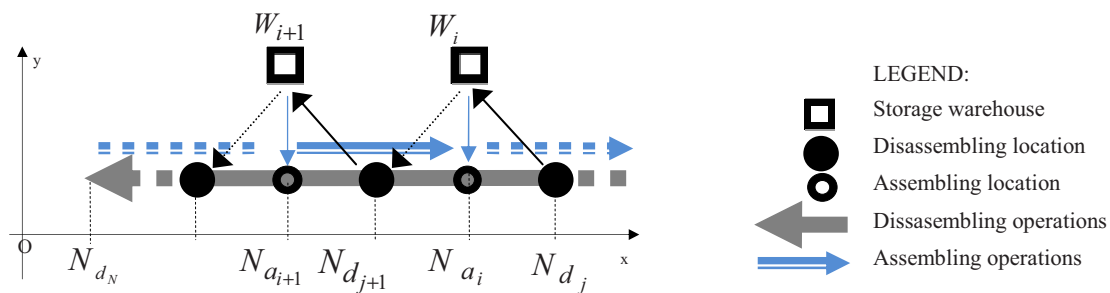

Fig.4: Assembly/Disassembly and storage warehouse locations

It consider the following notations (Fig.4):

- $N_{d_j}, j = \overline{1, N}$  - disassembly locations on the inverse sense of  $Ox$  axis. Obviously,  $i = N - j + 1$ .
- $N_{a_i}, i = \overline{1, N}$  - assembly locations on the positive sense of  $Ox$  axis.

- $W_i; i = \overline{1, N}$  - warehouse locations, which are identically with the assembly locations. Obviously,  
 $W_{N+1-j} \equiv W_i, j = \overline{1, N}$
- $D(N_{d_j}, W_{N+1-j})$  - distance between disassembly location  $N_{d_j}$  and the corresponding storage warehouse  $W_{N+1-j}$
- $D(W_{N+1-j}, N_{d_{j+1}})$  - distance between last storage warehouse  $W_{N+1-j}$  and the next disassembly location  $N_{d_{j+1}}$ .
- $D_{r_j} = D(N_{d_j}, W_{N+1-j}) + D(W_{N+1-j}, N_{d_{j+1}})$  - distance travelled by the mobile robot in the  $j$  stage of disassembly.
- $r = 1 + (j-1) \cdot 3$  - indexes a continuous place of the robot states,  $P_{cr}$ ;  $a$  - continuous transition of the robot,  $T_{cr}$  and a discrete transition of disassembly process  $T_{dd}$ .
- $k = 1 + (j-1) \cdot 5$  - indexes a discrete place of disassembly process,  $P_{dd}$ .
- $l = 1 + (j-1) \cdot 4$  - indexes a discrete place of the robot states,  $T_{dr}$ .

### 3. Generalized Model based Control of A/DML Served by WMR

#### 3.1. The Formalism of SHPN Model

The SHPN model associated to A/DML is a triplet

$$SHPN = \langle THPN, E, Sync \rangle \quad (1)$$

such that:

$THPN$  is a seventhly

$$THPN = \langle P, T, Pre, Post, m_0, h, tempo \rangle \quad (2)$$

$E$  is a set of external events

$$E = \left\{ Edd_i^1, Edd_j^2 \right\}_{\substack{i=1+3 \cdot (k-1) \\ j=3 \cdot (k-1) \\ k=1, \overline{N}}} \cup \{e\} \quad (3)$$

$Sync$  is a function from the set of the discrete disassembly transitions to the set of external events

$$Sync: T \rightarrow \{E^1, E^2\} \cup \{e\} \quad (4)$$

where  $e$  is the always occurring event (it is the neutral element of the monoid  $E^*$ ) and

$$\begin{aligned} Sync: \{Tdd_r\}_{r=1+3 \cdot (k-1)_{k=1, \overline{N}}} &\rightarrow \{E^1, E^2\} \quad (5) \\ Sync: \{Tdd_i\}_{i=3 \cdot (k-1)_{k=2, \overline{N}}} &\rightarrow \{Edd_i^2\}_{i=3 \cdot (k-1)_{k=2, \overline{N}}} \\ Sync: T \setminus \{Tdd_r\}_{r=1, 3+3 \cdot (N-1)} \cup \{Tdr_l\}_{l=1, 4+5 \cdot (N-1)} \\ &\cup \{Tcr_r\}_{r=1, 3+3 \cdot (N-1)} \rightarrow e \\ P = \{P_1, P_2, \dots, P_n\} &= P^D \cup P^C \quad (6) \end{aligned}$$

is a finite, not empty, set of places with  $P^D$  the set of discrete places and  $P^C$  the set of continuous places

$$P^C = \{P_{cr_k}\}_{k=0, 3+3 \cdot (N-1)}, \quad (7)$$

$$\begin{aligned} P^D = \{Pda_i\}_{i=1, 13+4 \cdot (N-1)} \cup \{Pdd_r\}_{r=1, 5+5 \cdot (N-1)} \\ \cup \{Pdr_s\}_{s=1, 4+8 \cdot (N-1)} \quad (8) \end{aligned}$$

where:

$\{Pda_i\}$  is the set of discrete places for assembly process;  
 $\{Pdd_j\}$  is the set of discrete places for disassembly process;  
 $\{Pdr_k\}$  is the set of discrete places for the states of mobile robot while serving disassembly process;  
 $\{Pcr_k\}$  is the set of continuous places associated to the distances performing by the mobile robot for each disassembly operation in order to transport the disassembled component from the disassembled location to the storage location;

$$T = \{T_1, T_2, \dots, T_m\} = T^D \cup T^C \quad (9)$$

is a finite, not empty, set of transitions with  $T^D$  the set of discrete transitions

$$\begin{aligned} T^D = \{Tda_i\}_{i=1, 7+2 \cdot N} \cup \{Tdd_r\}_{r=1, 3+3 \cdot (N-1)} \\ \cup \{Tdr_l\}_{l=1, 4+5 \cdot (N-1)} \quad (10) \end{aligned}$$

and  $T^C$  the set of continuous transitions

$$T^C = \{Tcr_r\}_{r=1, 3+3 \cdot (N-1)} \quad (11)$$

where:

$\{Tda_i\}$  is the set of discrete transitions for assembly operations model;  $\{Tdd_j\}$  is the set of discrete transitions for disassembly operations model;  $\{Tdr_k\}$  is the set of discrete transitions for states of mobile robot while serving disassembly operations;  $\{Tcr_k\}$  is the set of continuous transitions associated to distances performing by the mobile robot for each disassembly operation. To these transitions is associated the maximum linear speed of the WMR.

$Pre: P \times T \rightarrow Q_+$  or  $N$  is the input incidence application;

$Post: P \times T \rightarrow Q_+$  or  $N$  is the output incidence application;

$m_0: P \rightarrow R_+$  or  $N$  is the initial marking;

$$h: P \cup T \rightarrow \{D, C\} \quad (12)$$

called "hybrid function", indicates for every node whether it is a discrete node (sets  $P^D$  and  $T^D$ ) or a continuous one (sets  $P^C$  and  $T^C$ ),

$$\begin{aligned} h: P^D \cup T^D &\rightarrow \{D\} \\ h: P^C \cup T^C &\rightarrow \{C\} \quad (13) \end{aligned}$$

$tempo$  is a function from the set  $T$  of transitions to the set of positive or zero rational numbers,

$$tempo: T \rightarrow Q_+ \cup \{0\} \quad (14)$$

If  $T_j \in T^D$ , then  $d_j = tempo(T_j)$  is timing associated with  $T_j$ . For each discrete assembly transition of the set

$$T_a^D = \{Tda_i\}_{i=2, k=1, \overline{N}} \cup \{Tda_{2.(N+1)}\} \quad (15)$$

$$tempo(Tda_i) = d_{da_i} \quad (16)$$

#### 4. Generalised approach to Time Cycle Optimization for Disassembling Operations

The elementary time cycle (ETC) for the mobile robot  $ETC_R$ , corresponding to the e\_SHPN model, stage  $j$ , is the

where  $d_{da_i}$  represents the duration (in seconds) associated to the corresponding assembly operation.

travel duration with constant speed between  $N_{d_j}$  - the disassembling location,  $W_i$  - the storage warehouse,  $N_{d_{j+1}}$  - the next disassembling location added to durations of disassembly and manipulation operations performed by mobile robot (Fig.5):

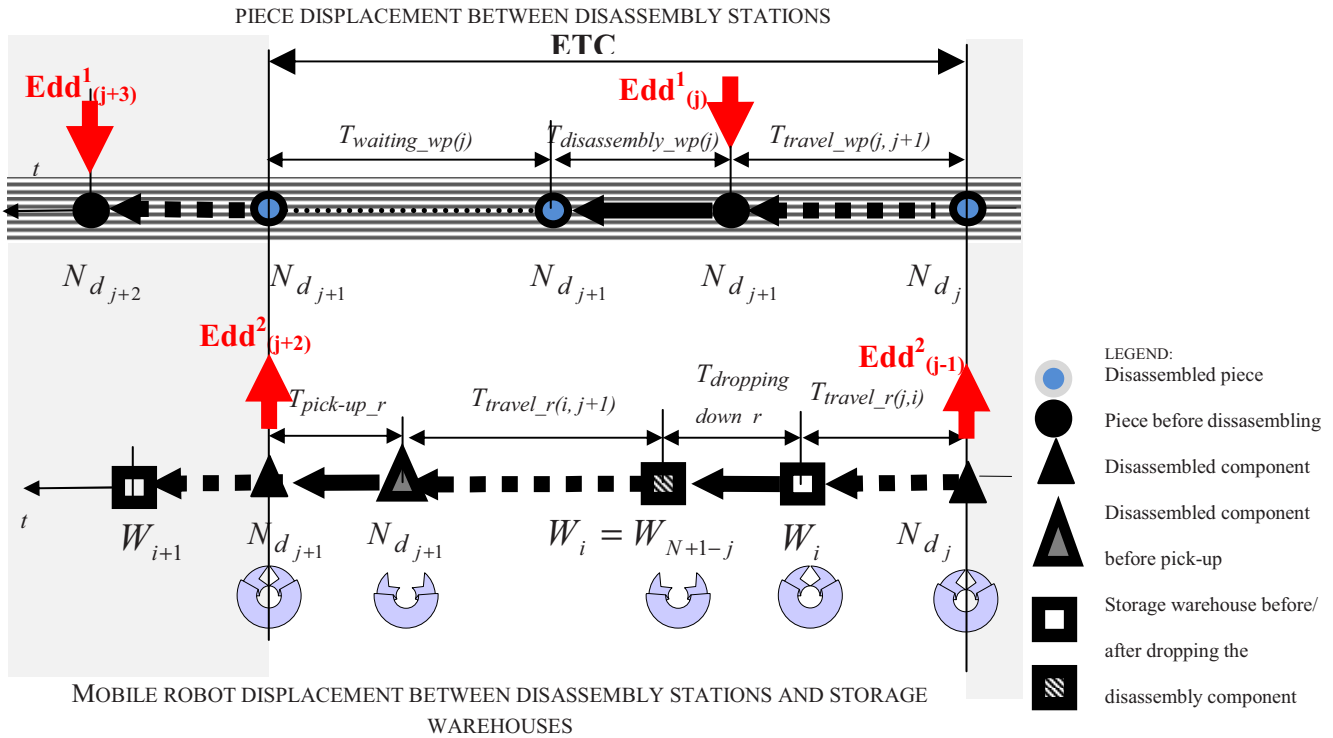

Fig. 5: Time sequences of the mobile robot and workpiece during an elementary sequence of disassembly

##### 4.1 ETC calculation in mobile robot cycle approach

$T_{travel\_r(j,i)} + T_{travel\_r(i,j+1)}$  is the travel duration between  $N_{d_j}$  - the disassembling location to  $W_i$  - the storage warehouse and between  $W_i$  - the storage warehouse to  $N_{d_{j+1}}$  - the next disassembling location:

$D(N_{d_j}, W_{N+1-j}) / V_r + D(W_{N+1-j}, N_{d_{j+1}}) / V_r$  where  $V_r$  is the mobile robot speed. For the  $N_{d_j}$  station the mobile robot starts moving towards the storage warehouse once the following sequences are completed: the pick-up of disassembled components and the gripper closure. These actions are synchronized by the synchronization signal  $E_{dd_j}^2 \Big|_{j=3, (k-1)}^{k=1, N}$  with the start of the workpiece travel towards

the next disassembly station. In e\_SHPN this durations

corresponding of timing associated with continuous transitions  $T^C$ :

$$T_{travel\_r_j} = tempo(Tcr_r) \Big|_{r=3+3 \cdot (j-1)} \quad (17)$$

$$T_{travel\_r_{j+1}} = tempo(Tcr_{r+2}) \Big|_{r=3+3 \cdot (j-1)} \quad (18)$$

where:

$$\{Tcr_r, Tcr_{r+2}\} \subset T^C, T^C = \{Tcr_r\}_{r=3+3 \cdot (j-1), j=1, \overline{N}}$$

$$m_{cr(r+1)} = V_r \cdot w(Tcr_r \times Pcr_{r+1}) = V_r \cdot w_r \quad (19)$$

$$m_{cr(r+2)} = V_r \cdot w(Tcr_{r+1} \times Pcr_{r+2}) = V_r \cdot w_{r+1} \quad (20)$$

and  $w_r = (Tcr_{r-1} \times Pcr_r) \Big|_{r=1+3 \cdot (j-1), j=1, \overline{N}}$

$$\begin{cases} w_r = D(W_{N+1-j}, N_{d_{j+1}}) / D(N_{d_j}, W_{N+1-j}) \\ w_{r+1} = D(N_{d_{j+1}}, W_{N-j}) / D(W_{N+1-j}, N_{d_{j+1}}) \end{cases} \quad (21)$$

The durations of picking-up and dropping-down the disassembled components corresponding of manipulation actions for the  $j$  stage. In e\_SHPN this durations corresponding of timing associated with discrete transitions

$$T^D = \{T_{dd_i}\}_{i=1,7+2.N} \cup \{T_{dd_r}\}_{r=1,3+3.(N-1)} \cup \{T_{dr_l}\}_{l=1,4+5.(N-1)}$$

$$T_{pick-up\_r_j} = d_{d_{l+2}} \Big|_{l=1+(j-1)4} = d_{d_{r_3+(j-1)4}} \Big|_{j=1, \overline{N}} \quad (22)$$

$$T_{dropping\_down\_r_j} = d_{d_{l+3}} \Big|_{l=1+(j-1)4} = d_{d_{4+(j-1)4}} \Big|_{j=1, \overline{N}} \quad (23)$$

$l=1+(j-1) \cdot 4$  - indexes a discrete place of the robot states.

The time cycle duration and its values components can be identified within the temporal marking evolution (Fig.8) corresponding to  $j$  stage of disassembly in SHPN model. In this case the ETC for the mobile robot-  $ETC_R$ , corresponding to  $j$  stage, are:

$$ETC_{R_j} = T_{travel\_r_j} + T_{travel\_r_{j+1}} + T_{pick-up\_r_j} + T_{dropping\_down\_r_j} \quad (24)$$

$$ETC_{R_j} = D(N_{d_j}, W_{N+1-j}) / V_r + D(W_{N+1-j}, N_{d_{j+1}}) / V_r + d_{d_{r_3+(j-1)4}} + d_{d_{4+(j-1)4}} \Big|_{j=1, \overline{N}} \quad (25)$$

## 4.2 ETC calculation in workpiece cycle approach

The workpiece makes successive travels between disassembly stations. The actions STOP / START line disassembly, or START disassembly / picking up of disassembled component are triggered by external synchronization signals  $E_{dd(j)}^1$  is an external synchronization signal, corresponding to STOPPING line and STARTING disassembly.  $E_{dd(j+2)}^2$  is an external synchronization signals, corresponding to PICKING UP of disassembled component and STARTING line.

$T_{travel\_wp_j, j+1}$  is the travel duration workpiece between  $N_{d_j}$  - the disassembling location to  $N_{d_{j+1}}$  - the next disassembling location.  $T_{disassembly\_wp_j}$  is the duration of disassembly operation for  $j$  stage. The commands START disassembly is launched after the  $E_{dd(j)}^1$  synchronisation signal reception. During  $T_{waiting\_wp_j}$  the workpiece expected the end of pick-up action performed by the mobile robot. In this case the elementary time cycle in the workpiece approach  $ETC_{WP}$  is:

$$ETC_{WP_j} = T_{travel\_wp_j, j+1} + T_{disassembly\_wp_j} + T_{waiting\_wp_j} \quad (26)$$

$$ETC_{WP_j} = d_{dd_r} \Big|_{r=1+(j-1)3} + d_{dd_{r+2}} \Big|_{r=1+(j-1)3} + T_{waiting\_wp_j} \quad (27)$$

The optimization of time cycle (TC) for the mobile robot approach implies the minimization of disassembly operations duration (if possible) and the minimization of manipulation durations. Optimal value for the optimal cycle time (TCO) becomes:

$$TC = \sum_{j=1, N-1} ETC_{R_j} = \sum_{j=1, N-1} ETC_{WP_j} \quad (28)$$

$$TCO = \min \sum_{j=1, N-1} ETC_{R_j} \geq \min \sum_{j=1, N-1} ETC_{WP_j} \quad (29)$$

$$TCO = \sum_{j=1}^{N-1} D(N_{d_j}, W_{N+1-j}) / V_{r\_opt_j} + \min \sum_r \left( d_{d_{r_3+(j-1)4}} + d_{d_{4+(j-1)4}} \right) \Big|_{j=1, \overline{N}} + \sum_{j=1}^{N-1} D(W_{N+1-j}, N_{d_{j+1}}) / V_{r\_opt_j} \quad (30)$$

At the same time it must be provided the temporal synchronization between  $\min(ETC_{R_j})$  and  $\min(ETC_{WP_j})$  for each  $j$  stage. For the SHPN model this restriction is equivalent to avoid the blockage for PN model:

$$\min(ETC_{R_j}) = D(N_{d_j}, W_{N+1-j}) / V_r + D(W_{N+1-j}, N_{d_{j+1}}) / V_r + \min(d_{d_{r_3+(j-1)4}} + d_{d_{4+(j-1)4}}) \quad (31)$$

$$\min(ETC_{WP_j}) = d_{dd_r} \Big|_{r=1+(j-1)3} + d_{dd_{r+2}} \Big|_{r=1+(j-1)3} \quad (32)$$

$$\min(ETC_{R_j}) = \min(ETC_{WP_j}) \Rightarrow V_{r\_optimum_j} \quad (33)$$

$$V_{r\_opt_j} = \frac{d_{dd_{j-2}} + d_{dd_j} - \min(d_{d_{r_3+(j-1)4}} + d_{d_{4+(j-1)4}})}{D(N_{d_j}, W_{N+1-j}) + D(W_{N+1-j}, N_{d_{j+1}})} \quad (34)$$

$$V_{RO} = \min \{ V_{r\_opt_j} \}_{j=1, \overline{N}} \quad (35)$$

$$TCO = \sum_{j=1}^{N-1} D(N_{d_j}, W_{N+1-j}) / V_{RO} + \min \sum_r \left( d_{d_{r_3+(j-1)4}} + d_{d_{4+(j-1)4}} \right) \Big|_{j=1, \overline{N}} + \sum_{j=1}^{N-1} D(W_{N+1-j}, N_{d_{j+1}}) / V_{RO} \quad (36)$$

## 5. Real-Time Control Based on A/DML and SHPN Models

The SHPN model is transposed under LabView platform in a real-time application, obtained by interfacing HPN model with synchronized signals taken by acquisition from the real process. The synchronization signals, used in the LabView application of real-time control, validate certain

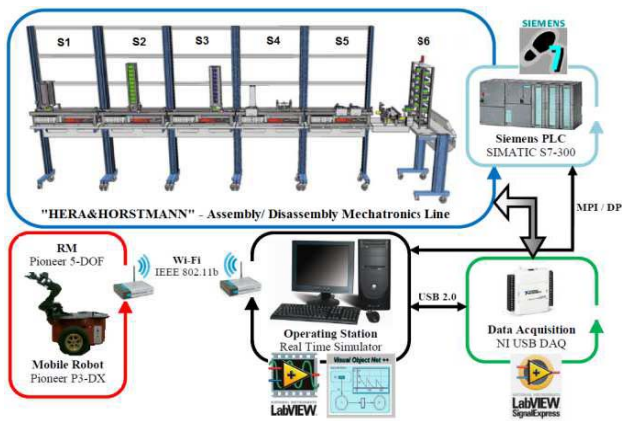

Fig.6: Control structure of A/DML Hera&Horstmann served by WMR with RM

transitions into SHPN model. Discrete time, sliding-mode control, in trajectory-tracking, based on kinematic model is used in order to control WMR.

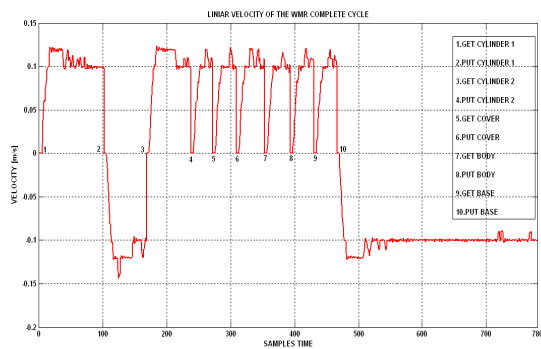

Fig.7: Displacement speed of WMR during disassembly operations

In this way both the robot and flexible line are controlled, in order to achieve a minimal time cycle of assembly/disassembly. The initialization of the robot is performed by a signal transmitted through a wireless access point mounted on the robot, received by the LabView application. The signal transmitted to PLC of A/DML by Linear velocity of the WMR disassembly complete cycle in trajectory tracking, real-time, sliding-mode control is presented in Fig.7. The complete structure of the A/DML real-time control served by WMR is shown in Fig.6.

## 6. Conclusions

A SHPN model, in synchronized form, based real-time control of fully reversible assembly/disassembly mechatronics line is presented in this paper. The SHPN model is conditioned on certain state transitions by external events representing signals supplied by sensors. The A/DML is served by a WMR equipped with RM which is used only in disassembling in order to transport the disassembled components to the storage warehouses. An

optimization approach of time cycle for repetitive processes is proposed. Therefore, the assembly line becomes reversible, i.e. executes automated disassembly. A disassembly process is started when the final product, obtained by assembly, fails quality test. The hybrid control system takes into account the distribution of the necessary tasks to perform the disassembly of components by using the robot synchronization with the A/DML.

## Acknowledgements

This work was supported by UEFISCDI, project number PN-II-ID-PCE-2011-3-0641

## References

- [1] Baldwin, D. F. , Abell, T. E. , Lui, C. M. , De Fazio, T. L. , Whitney, D. E . An integrated computer aid for generation and evaluation assembly sequences for mechanical products, *IEEE Transactions on Robotics until Automation*, 1991, pp. 78-94.
- [2] Choi, C. K. , Zhang., X. F. , Ng, T. L. , Lau, W. S. , On the generation of product assembly sequences, *International Journal of Production Research*, 1998, pp. 617-633.
- [3] David, R. and Alla, H., *Discrete, Continuous and Hybrid Petri Nets*, ISBN 978-3-642-10668-2, Springer Verlag, Berlin Heidelberg, 2010. J
- [4] Ganget, J., Hattenberger, G. , and Alami, R. , Task planning and control for multi-UAV system:architecture and algorithms, *IEEE Intl. Conf. On Intelligent Robot and System*, Vol.18, 758-768, 2005.
- [5] Seliger, G. , Grudzien, W. , Zaidi, H., New methods of product data provision for a simplified disassembly, *Proceedings of the 6th International Seminar on Life Cycle Engineering*, Kingston, Canada, June 21–23, 1999. p. 250–9.
- [6] Minca E., A Theoretical Approach of the Time Cycle Optimisation Based Control of a Mechatronics Line Served by Mobile Robot, *Applied Mechanics and Materials Vols. 321-324 (2013) pp 1666-1669*, © (2013) Trans Tech Publications, Switzerland
- [7] Radaschin, A. , Voda, A. , Minca, E. , Filipescu, A. , Task Planning Algorithm in Hybrid Assembly/Disassembly Process, *14th IFAC Symposium on Information Control Problems in Manufacturing*, May 23-25, 2012, Bucharest, ISSN: 1474-6670; ISBN: 978-3-902661-98-2, pp. 571-576.
- [8] Kopacek, B. , Kopacek, P., Robots for disassembly, *Proceedings of the 30th International Symposium on Robotics*, Tokyo, pp 207–212.
- [9] David, R. and Alla, H., *Discrete, Continuous and Hybrid Petri Nets*, ISBN 978-3-642-10668-2, Springer-Verlag Berlin Heidelberg, 2010.
- [10] Filipescu, A. , Filipescu, S. , Minca, E. , Hybrid System Control of an Assembly/Disassembly Mechatronic Line Using Robotic Manipulator Mounted on Mobile Platform, *The 7th IEEE Conference on Industrial Electronics and Applications (ICIEA2012)*, 18-20 July,2012, Singapore, pp. 433-438, IEEE Catalog Number CFP 1220A-CDR, ISBN: 978-1-4577-2117-5.